

Article number: 204160M16100D0U

Description: E+G levelling foot
GN 41-60-M16-100-D0-U

Note: U Without nut, Hexagon socket at the top, Wrench flat at the bottom

Measures

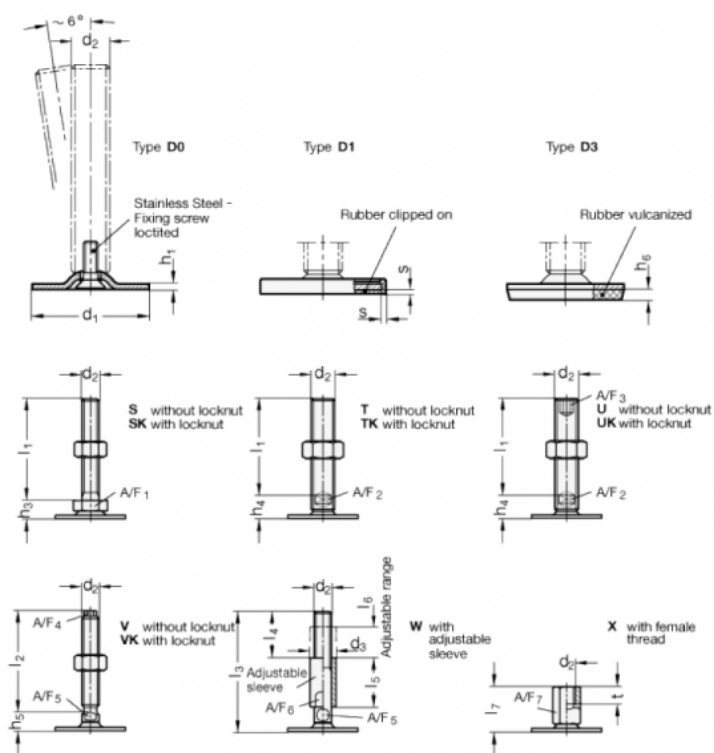

A/F2 = 12

s =

A/F3 = 8

d1 = 60

d2 = M16

h1 = 2.5

h4 = 17

h6 =

l1 = 100